

TO: GENERAL COMMITTEE

SUBJECT: ZONING FOR INTENSIFICATION AND MIXED-USE

WARD: ALL

PREPARED BY AND KEY CONTACT: A. SHAIKH, PLANNER
EXT. #4434

SUBMITTED BY: S. NAYLOR, MES, M.C.I.P., R.P.P.
DIRECTOR OF PLANNING SERVICES 

GENERAL MANAGER APPROVAL: D. FRIARY, GENERAL MANAGER OF INFRASTRUCTURE & GROWTH
MANAGEMENT (ACTING) 

CHIEF ADMINISTRATIVE OFFICER APPROVAL: C. LADD, CHIEF ADMINISTRATIVE OFFICER 

RECOMMENDED MOTION

1. That the Official Plan Amendment for the addition of Section 4.9 "Mixed Use", as included in Appendix "A" attached to Staff Report PLN018-14, be approved.
2. That the Zoning By-law Amendment for the addition of Section 5.4 "Mixed Use" and an amendment to Section 4.6 "Parking Standards", as included in Appendix "B" attached to Staff Report PLN018-14, be approved.
3. That staff be directed to investigate the appropriateness of pre-zoning select areas of the Intensification Nodes and Corridors and report back to Council.

PURPOSE & BACKGROUND

Purpose

4. The purpose of this Staff Report is to recommend an amendment to the City's Official Plan and implementing zoning standards to facilitate medium and high density development within the Intensification Areas, as identified on Schedule I of the City of Barrie Official Plan (see Appendix "C").

Background

5. On December 16 2013, City Council adopted motion 13-G-317 regarding "Proposed Intensification Nodes and Corridors" as follows:

"That a public meeting be scheduled to consider a Zoning By-law Amendment to facilitate the creation of a new 'Mixed-use' zoning category, the creation of two new zones for the intensification nodes and corridors, and an amendment to the parking standards applicable to residential uses within the intensification areas."
6. Planning Services staff held a series of public and stakeholder consultation sessions in order to present and receive feedback on the proposed new zoning standards. Focus groups were held on February 28th, 2014 and March 7th, 2014 with members of the professional building and land development industry. Members of the general public were engaged through an open house held

on March 11th, 2014, and a public meeting held on March 31st, 2014. A summary of comments received at these meetings will be addressed later in this Staff Report.

Provincial Policy Statement

7. The Provincial Policy Statement (PPS) establishes a broad framework for directing growth to achieve efficient development and land use patterns, including intensification.
8. Section 1.1 states that "sufficient land shall be made available through intensification and redevelopment and, if necessary, designated growth areas, to accommodate an appropriate range and mix of employment opportunities, housing and other land uses to meet projected needs..." More specifically, the PPS provides direction to make amendments to the Zoning By-law that supports intensification, stating that "Appropriate development standards should be promoted which facilitate intensification, redevelopment, and compact form..."

Growth Plan for the Greater Golden Horseshoe

9. The Growth Plan for the Greater Golden Horseshoe is explicit in its support of intensification, setting growth targets for municipalities and providing strong guidance on the built form envisioned for intensification areas. The Growth Plan states that all intensification areas will be planned and designed to:
 - a) *cumulatively attract a significant portion of population and employment growth;*
 - b) *provide a diverse and compatible mix of land uses, including residential and employment uses, to support vibrant neighbourhoods;*
 - c) *provide high quality public open spaces with site design and urban design standards that create attractive and vibrant places;*
 - d) *support transit, walking and cycling for everyday activities;*
 - e) *generally achieve higher densities than the surrounding areas;*
 - f) *achieve an appropriate transition of built form to surrounding areas.*

City of Barrie Official Plan and Intensification Study

10. In accordance with Provincial policy, the City prepared an Intensification Study which has been implemented through the City's Official Plan which identifies areas of focus for Intensification and provides some policy guidance with regard to the development of these areas. The type of development envisioned through intensification is described as:

"Intensification will contribute to development that is more compact and will efficiently use land and resources, optimize the use of existing and new infrastructure and services, support public transit and active transportation, contribute to improving air quality and promoting energy efficiency."

11. The City's approved Intensification Strategy and implementing Official Plan provisions establishes a node and corridor strategy that builds upon opportunities already found within the City of Barrie. The geographic layout of the City lends itself to natural locations for intensification along the arterial roads that connect the UGC (see Appendix "C" for map of the Intensification Areas). These areas represent some of the best opportunities for achieving the objectives described

above, including higher densities, support for a mix of uses, and the creation of a strong pedestrian realm.

12. The intensification nodes are found at major intersections along these corridors. These locations already experience higher traffic volumes and are highly visible from the street. In many cases, the intersections contain existing commercial uses, or are zoned for future commercial development. These factors contribute in making the intensification nodes ideal places for higher density mixed-use development. The variety of shops, services, and community facilities located here will also service the adjacent intensification corridors and the existing surrounding residential neighbourhoods.
13. Being located along the City's major arterial roads, the node and corridor strategy links together land use policy with transportation planning, encouraging walking, cycling, and public transit usage. As densities continue to increase, the viability of offering expanded public transit service also increases.

ANALYSIS

14. The City of Barrie has experienced considerable growth during the past several decades at a time where conventional planning philosophy sought to separate out land uses based on their function as a means of protecting sensitive residential areas from potentially conflicting commercial and industrial uses.
15. The result of this planning model is a greater reliance on the automobile to travel from residential areas to meet basic daily needs such as to purchase goods and services, reach community facilities, or commute to workplaces. Roads were accordingly engineered to most efficiently move automobiles throughout cities, with less regard for other forms of mobility and access. Cities began an outward expansion by consuming substantial areas of vacant greenfield land, creating a need to travel significant distances to access daily destinations.
16. The intent of the proposed standards and policies recommended by this Staff Report are to begin to reverse the effects of the previous planning model by strategically fostering mixed-use medium and high density development. These changes recognize that pedestrian environments are increasingly being demanded by residents and that the economy is shifting towards businesses that are seeking out mixed use office locations. Intensification and mixed-use development also make better use of City services and infrastructure, promote improved public health, and is regarded as sustainable form of development.
17. The standards and policies recommended by this Staff Report are intended to achieve three primary objectives, each of which is critical to realise the full potential of the Intensification Areas. These primary objectives are described below:
 - a) *Facilitate medium and high density development throughout the Intensification Nodes and Corridors to support future population growth.*

The Growth Plan projects the City of Barrie's population to reach 253,000 by 2041, and states that by 2015 and each year thereafter, 40% of all residential development will occur within the built-up area.

Planning for higher densities within the Intensification Areas will allow the City to accommodate this projected population growth within the designated "built boundary" in a planned and strategic manner. Higher densities provide a sufficient population threshold necessary to attract a wider variety of local retail and services into the neighbourhood, as well as to make improved public transit service more financially feasible.

- b) *Create complete communities that support a mix and variety of uses and activities to fulfil a range of needs.*

Complete communities are places that support an array of activities and fulfil a variety of needs, creating diverse neighbourhoods with opportunities to live, work, and play. These neighbourhoods offer improved access to destinations travelled to on a day-to-day basis within close proximity to the home. Those destinations can include retail shops and services, public parks and open space, and various institutional facilities such as libraries or recreation centres.

To truly achieve a complete community, these mixed-use areas must be supported by multiple modes of transportation, including walking, cycling, public transit, and the automobile. Equally important is the ability to support a variety of built forms, providing a range of affordability for places to live and work.

- c) *Foster a vibrant pedestrian oriented environment featuring a compact built form that encourages greater walkability, cycling, and transit usage.*

A community becomes vibrant when the streets become active with people walking and enjoying the variety of uses offered by the neighbourhood. Neighbourhoods must be designed to be inviting for pedestrians in order to attract people out onto the streets. The pedestrian experience is improved in neighbourhoods that contain high densities and feature a compact built form, increasing the number of places that can be accessed on foot.

Further discussion on the need for public realm improvements to create a successful pedestrian realm is found later in this Staff Report.

Fundamentals for Successful Mixed Use Development

18. Staff have investigated examples of both successful and unsuccessful mixed use development in other Ontario municipalities. Understandably, mixed use development involves a greater level of complexity than conventional single use development. Research into existing examples of mixed use development reveal that their success depends largely on their ability to successfully incorporate a multitude of factors, which are described below. Staff note that the absence of any of these crucial factors has jeopardized the success of other examples across Ontario.
19. As is the case with all real estate, location continues to be the primary factor that attracts land development. Successful mixed use development should be located in high traffic areas that are easily accessed and adjacent to well-travelled roads.
20. Mixed use streets are most successful when they consist of multiple primary uses, drawing a variety of people into the neighbourhood for a variety of reasons. A primary use is explained as those which serve as the main draw of people into the neighbourhood, and often could function as standalone uses. Examples of this are residential uses, office buildings, public facilities such as libraries or recreation centres, and major retail operations. These uses serve as destination 'anchor tenants', generating traffic and movement throughout the neighbourhood and creating a strong local customer base.
21. As primary uses develop, a number of secondary uses emerge which prosper based on the local customer base created due to the presence of primary anchor uses. These secondary uses are often smaller and independent operations that contribute to providing a unique neighbourhood experience and are typically located in conjunction with a primary use, for example at the street

level of a residential or office building. Examples of secondary uses may include coffee shops, independent restaurants, fashion boutiques, specialty food or retail stores, and other small businesses. Attaining the right tenant mix between primary and secondary uses is important in significant large scale developments in mixed use areas.

22. Mixed use areas require a critical mass of people (residents, employees, consumers) coming into the neighbourhood to create the local market necessary for a variety of uses and activities to be supported. Permitting high density residential allows some of this population mass to be located directly within the community. Office buildings bring in a population of employees who spend several hours of the day in the neighbourhood, and will make use of restaurant, shopping, and personal services. With the gradual appearance of unique secondary uses, more visitors begin to come into the community for the distinct neighbourhood experience that mixed use areas can offer.
23. The design of the public realm can be an effective means of stitching together the variety of activities located in a mixed use neighbourhood. This includes the siting of buildings right up to property lines directly adjacent to sidewalks, sidewalks that are sufficiently wide to ensure a comfortable walking experience, bicycling lanes and frequent public transit service to support multi-modal transportation, and street furniture such as benches, lighting, and shelter to provide pedestrian comfort. Community parkettes, plazas, and other public open spaces serve as gathering places that can unite a neighbourhood and bring people together.
24. Urban design at the individual site level is of particular importance for retail operations in mixed use buildings. Mixed use buildings will need to be created with the targeted end-users in mind, designed to be open and inviting by providing optimum visibility and access from the street. For example, modern retail businesses often demand taller ceiling heights with plenty of glass and transparent materials to allow for product showrooms and promotional space. Office uses may be more flexible, instead being more conscious about location, rent and floor space.

Diversifying Barrie's Real Estate for Emerging Market Demands

25. Current real estate trends reveal a rising demand for compact and affordable housing located in neighbourhoods that offer a variety of activities to fulfil day-to-day needs. These trends demonstrate a strong preference for reaching these daily destinations within walking distances of the home, reducing a reliance on the automobile. Research indicates that this trend is prevalent amongst a younger generation of urban professionals who prefer a more urban lifestyle, as well as some segments of the baby-boom generation that are seeking opportunities to downsize into walkable and accessible neighbourhoods.
26. Ontario has been experiencing a shift from a primarily manufacturing-based economy towards a knowledge, service, and creativity based economy. These new businesses are increasingly choosing to locate in cities that are able to meet the lifestyle needs of the employees they intend to attract. The new economy employees are demanding walkable mixed use communities that offer multiple transportation options, feature a unique character and sense of place, and are able to offer culture and excitement.
27. The availability of housing and neighbourhood options to meet the demand for these emerging real estate market demands are currently limited in Barrie. Unlike the UGC, development within the intensification nodes and corridors do not benefit from views and proximity to Barrie's waterfront. In order to make these locations attractive and desirable to live for to new residents, the intensification nodes and corridors must offer the amenities, activities, and unique neighbourhood character that create the urban lifestyle increasingly being sought after.
28. A diversification of housing types can also result in a wider range of choice and affordability for residents. This is achieved through the development of a wider variety of dwelling unit size and

configuration, resulting in price and tenure variation. In general, compact multiple unit residential dwellings tend to be sold at a more affordable price point compared to the average single-detached dwelling.

Efficient Development

29. Intensification benefits the City by attaining a more efficient use of land and a better use of existing infrastructure, ultimately providing better value for taxpayers. Appreciating that land is a finite resource, intensification allows the City to achieve growth without the need to consume vast tracts of vacant greenfield land.
30. Intensification also results in a more intensive use of publicly funded facilities such as libraries, parks, or community centres. Higher densities increase the financial feasibility of providing more frequent and convenient public transit service for the Intensification Areas.
31. Staff acknowledges that infrastructure upgrades involving capital expenditure may be necessary in order to match the increased service levels (for water, sewers, roads, storm water ponds, community facilities) that would result from intensification.
32. Studies conducted by the Canadian Mortgage and Housing Corporation (CMHC, *Infrastructure Costs Associated with Conventional and Alternative Development Patterns*, Research Highlights – Socio-Economic Series: Issue 26) demonstrate that over the long term, the costs of servicing the mixed-use compact development pattern are less than the cost of servicing the conventional suburban development pattern.

The Health Benefits of Intensification and Mixed-Use Communities

33. A literature review produced by staff from the Simcoe Muskoka District Health Unit examines evidence linking the relationship between the built environment and human health (Williams, M., Wright, M. *The Impact of the Built Environment on the Health of the Population*, 2007). The research indicates that human health is improved in locations that feature increased densities, a mix of uses, and a pedestrian friendly environment. Select key findings are summarized below:
 - The research reviews evidence of the correlations between low densities and increased automobile reliance, with decreased physical activity and decreased overall human health.
 - Low density areas with a greater reliance on the automobile can result in residents who experience low physical activity and a sedentary lifestyle, contributing to obesity and escalating chronic disease rates.
 - Research reveals that increased density, land use mix, and connectivity is positively linked to greater physical activity and thus improved human health. The built environment is shown to encourage walkability and cycling where streets are designed for pedestrian friendliness, and where multiple destinations can be accessed locally without the need for an automobile.
 - Evidence indicates a linkage between the built environment and air quality associated with mode of transportation, with poor air quality being correlated with fossil-fuel based emissions. These emissions are caused by increased automobile usage found in lower density single-use areas.
 - The design of the built environment has an effect on an individual's mental health with respect to feelings of safety, fear, isolation, stress, depression and sense of belonging.

Social capital in the form of personal or professional networks and relationships are shown to increase in pedestrian friendly mixed-use environments by improving social ties and interactions between members of the community.

Public Realm Improvements

34. The standards and policies recommended in this Staff Report are intended to affect the development of private properties throughout the intensification nodes and corridors. However, in order to achieve the objectives outlined at the beginning of this report, changes and improvements will also be necessary to the public realm.
35. The public realm refers to the publicly owned streets, sidewalks, public parks and open spaces, civic buildings and community facilities, and other common areas not privately owned (see diagrams below).

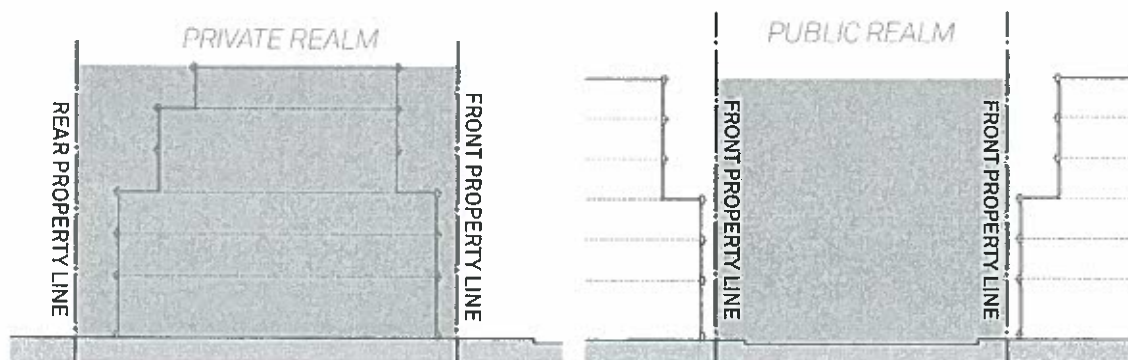

Figure 1 –Private Realm (left) and the Public Realm (right)

36. Improvements to the public realm are intended to enhance the urban experience on the street, providing benefit to residents and businesses. These improvements may include a sidewalk widening, bicycle lane construction, improvements to public transit service, and the installation of street furniture. Street furniture can include boulevard trees and planters, lighting, public transit shelters, bicycling parking, way finding signage, or public art.
37. The effect of these improvements is that the public realm is safer and more comfortable for pedestrians and cyclists, is more inviting for businesses to open up street level storefronts, and contributes towards providing a unique character and sense of place for the neighbourhood.
38. Public realm improvements can also come in the form of green features designed to provide both environmental and visual enhancement. Examples of this include the installation of in-boulevard bio-swales and permeable pavement to utilize a low-impact development (LID) approach to storm-water management.
39. The construction of public realm improvements are a capital cost that will need to be budgeted for by the City of Barrie as the intensification nodes and corridors are developed. These improvements will require collaboration amongst various affected City of Barrie departments in order to identify and co-ordinate the work needed to be completed. The Infrastructure & Growth Management Divisional Management Team (DMT) has had discussions on the formation of a cross-department steering committee intended to discuss this co-ordination effort going forward.

Summary of Recommended Zoning Standards

40. A recommended list of permitted uses for the proposed intensification area zones is provided in Appendix 'B'. This list of uses includes a combination of medium and high density multiple residential uses, a wide and varied range of commercial uses, as well as a selection of institutional uses that are considered compatible with residential and commercial areas.
41. It is recommended that both the intensification node and corridors permit the same uses (with the exception of automotive service station and drive through uses, discussed later in this Staff Report), as both of these zones are intended to function as mixed-use areas.
42. Staff recommend that the Intensification Nodes require the inclusion of commercial uses to be located at the ground floor level of new development. However, recognizing the necessity for the Intensification Nodes to gradually evolve into mixed use areas over time, exceptions to this requirement may be considered on a site-specific basis.
43. Staff recommend that the Intensification Corridors permit both mixed-use and single-use residential buildings. Mixed-use buildings in the Intensification Corridors will be incentivized by granting additional height permission for new development that includes ground floor commercial units.
44. The recommended zoning standards differ between the Intensification Nodes and the Intensification Corridors. The standards for the Intensification Corridors also differ depending on whether the development includes ground-floor commercial, or is a residential only building. Please refer to the complete table of the recommended standards as found in Appendix 'B' attached to this Staff Report.
45. A discussion of key features of the proposed development standards is provided below:

a) *Total Building Height (minimum & maximum)*

The intensification nodes are recommended a maximum height of 25.5 metres (8 storeys), and a minimum height of 10.5 metres (3 storeys).

The intensification corridors are recommended a minimum height of 7.5 metres (2 storeys) and a maximum height of 16.5 metres (5 storeys) for a building with residential uses only. If the building is mixed-use (with commercial uses located at the ground-floor level), the maximum height is recommended to increase to 25.5 metres (8 storeys).

These minimum heights are applicable on all facades of the building, including front, side, and rear facades.

The maximum building height is not inclusive of mechanical rooftop penthouses, which may extend the maximum height limit by an additional 5 metres.

b) *Minimum Height of Ground Floor Level*

The minimum floor-to-ceiling height of the ground floor is recommended to be 4.5 metres in order to facilitate retail uses at grade (see diagram below).

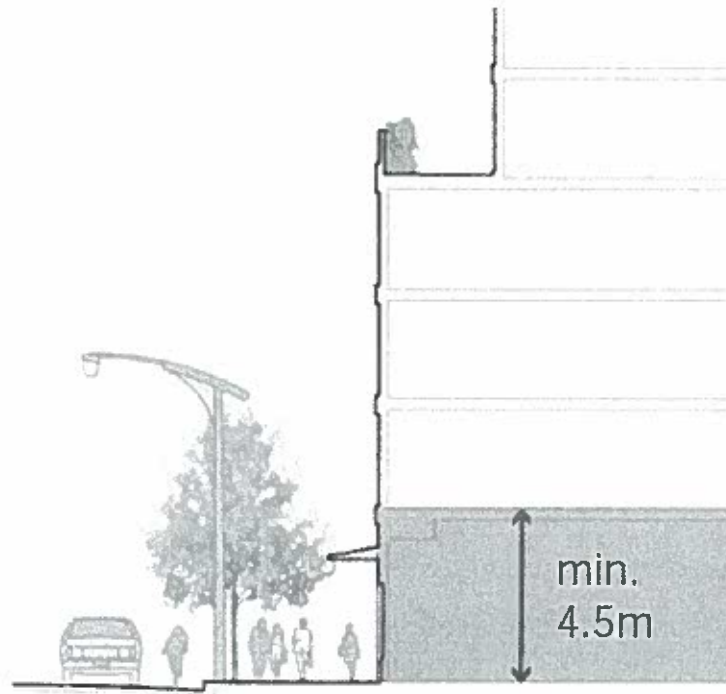

Figure 2 – Minimum height of ground floor level

Staff recommend that single-use residential-only buildings be permitted in the intensification corridors, recognizing that a market may not currently be available for ground floor commercial uses in some locations. However, it is recommended that a ground floor height of 4.5 metres continue to be required for residential-only buildings to accommodate the potential for future conversion to a mixed-use building once the commercial market emerges, and to facilitate live-work uses in the interim.

c) *Front Façade Step-Backs (streetwall height)*

The front facade of the building (also referred to as the streetwall height) envelope should be stepped-back with a 45 degree incline at any point taller than the equivalent to 80% of the adjacent street right-of-way. Each step-back should be a minimum of 3 metres.

For example, for a street containing a 20 metre right-of-way (R.O.W.), a 45 degree angular plane would apply at any point taller than 16 metres (which represents 80% of the R.O.W. width). Please refer to the diagram below for an illustrated example of these provisions.

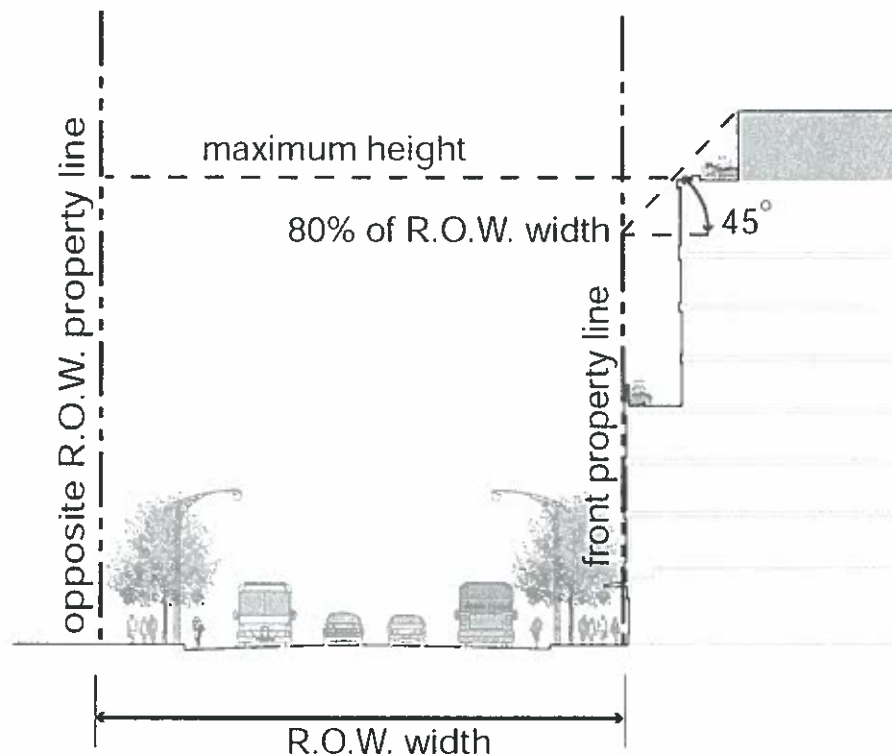

Figure 3 – Front Façade Step-Backs (streetwall height)

The use of a stepping provision for building height above the equivalent of 80% of the adjacent right-of-way ensures that views of the sky are maintained, allows greater penetration of sunlight onto the street, and also helps to reduce the visual and physical impact of building height, such as shadowing. This standard also applies to mechanical rooftop penthouses.

For comparison, the City's current standards for the Central Area C1-1 zones includes a stepping provision whereby the first 10 metres of building height can be located right at the property line (a 0 metre setback), and any portion of the building taller than 10 metres is required to be stepped back 5 metres from the property line, up to a maximum of 30 metres tall. The purpose of this provision is to ensure that new development maintains the look of the traditional three-storey building character along Dunlop Street. However, without the additional provisions requiring step-backs above any point taller than the equivalent to 80% of the adjacent right-of-way, sky views may not be maintained and pedestrians may be further impacted by shadowing.

Note the difference between setbacks and step-backs (see diagram below). Setbacks refer to the location of the exterior wall at the ground floor level in relation to the property lines. Step-backs refer to a step-like recession of the exterior wall at points of the wall above the ground floor level.

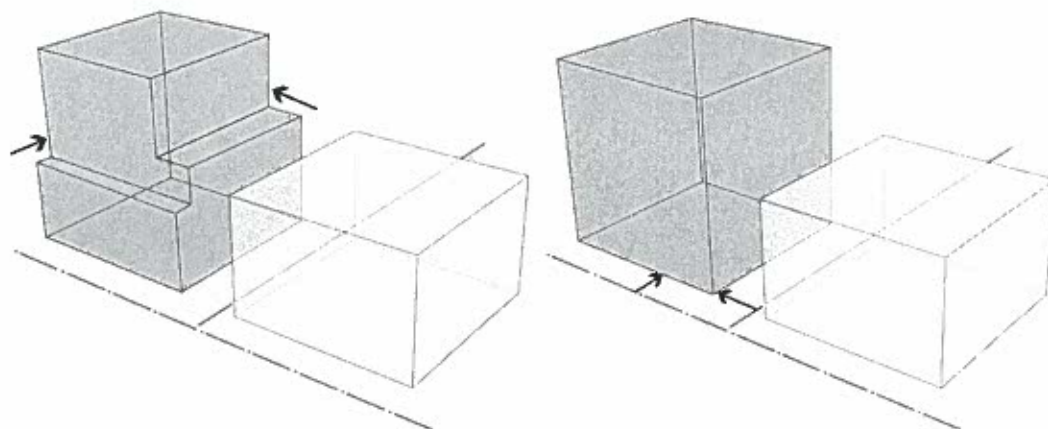

Figure 4 -- Step-backs at upper storeys (left) and Setbacks at ground level (right)

c) *Front Yard Setbacks (minimum & maximum)*

Building up to the property line will encourage an urban built form that will facilitate a pedestrian oriented realm that is not overborne by parked vehicles. A maximum of 25% of the front yard frontage may be setback 5 metres away from the property line in order to create additional sidewalk or patio space, to delineate entranceways with weather protection features, or simply for architectural interest. Parking will not be permitted within the front yard setback.

Staff recommend that ground related residential buildings such as street townhouses located within the intensification corridors be permitted a setback of 3 metres away from the property line, in order to provide additional privacy.

Siting a building directly on the property line may be difficult to achieve on some properties, for example those with grading or topography challenges. In other situations, a developer may request a larger setback to provide additional front yard space for patio usage or other unique feature. The standards recommended in this Staff Report are not intended to accommodate for every possible property nuance. In these site-specific situations, a minor variance application to the Committee of Adjustment is an appropriate mechanism for obtaining relief from this standard. If Council approves staff's recommendation to produce a strategy for pre-zoning the intensification nodes and corridors, the pre-zoning exercise may be used to adjust the standards in response to specific property characteristics, such as grading concerns.

d) *Side Yard Setbacks (minimum & maximum)*

Zero metre (0m) setbacks at the side yards are recommended for the purpose of consolidating buildings and facilitating a more urban environment in the Intensification Nodes and Corridors.

When adjacent to a street or laneway, a side yard setback of 3 metres is recommended to be required in order to accommodate for a potential street road widening and to

provide space for temporary snow storage, until snow can be lifted and removed from the property.

A maximum side yard setback of 6 metres is recommended for buildings within the Intensification Corridors in order to provide sufficient area for two-way driveway access to a rear parking lot.

e) *Rear Yard Setbacks and Transition to Adjacent Rear Properties*

Where the rear yard of a building is adjacent to existing low-rise residential neighbourhoods, buildings should be setback 7.5 metres along the rear frontage. Where adjacent to a street or laneway, buildings should be setback 1.5 metres. Streets or laneways may refer to either public or private vehicular right-of-ways.

The rear facade of the building envelope should be stepped-back with a 45 degree incline at any point taller than the applicable minimum building height. Step-backs should be a minimum of 3 metres. Please refer to the diagram below for an illustrated example of these provisions.

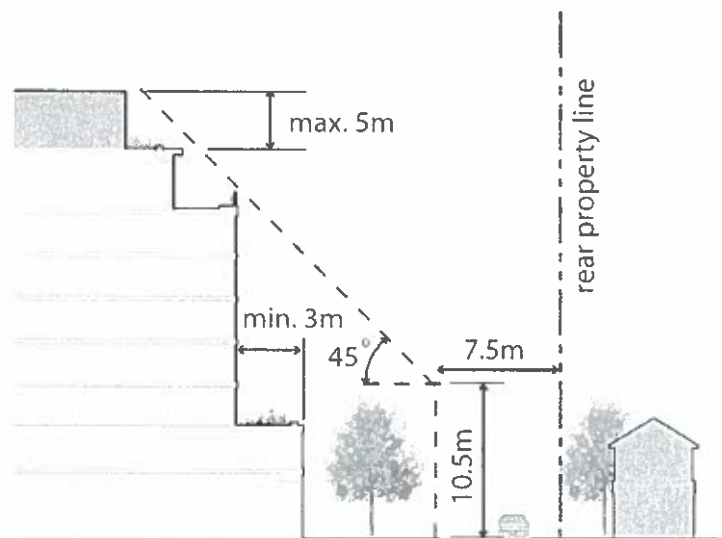

Figure 5 – Rear Yard Setback and Transition to Adjacent Property in the Intensification Node

f) *Lot Area (Minimum)*

It is recommended that no minimum lot area be required for these zones. The intention behind this is to promote diversity in the built form options and increase the variety of viable land uses. Land developers would be able to construct on any lot area size permitted that they are able to meet all other development standards, particularly the maximum front and side yard setbacks and maximum building height.

g) *Lot Frontage (Minimum)*

No minimum lot frontage is recommended for the Intensification Nodes and Corridors in order to permit built form variety.

h) *Minimum Coverage for Commercial Uses (% of building footprint)*

Staff recommend that a minimum of 50% of the building footprint (being the floor area of the building's ground level floor) will be devoted to commercial uses, to be located at the front of the building with primary entrances accessed from the street. This matches the minimum commercial use coverage standard found in the City Centre's Commercial zones. Upholding this standard is imperative to achieving the goals of a mixed-use pedestrian oriented environment for the intensification areas. This requirement will not apply to the intensification corridors when a building is strictly residential use only.

i) *Parking for Residential Dwelling Units*

A standard of 1 parking space per residential dwelling unit is recommended for both of the proposed zones, as well as the Urban Growth Centre area. This proposed standard would reduce the present minimum parking space requirement of 1.5 spaces per unit for residential dwellings of 3 or more units.

The Intensification Study makes recommendations for reduced parking space standards for residential buildings in the intensification areas. The intensification areas are intended to be pedestrian friendly, transit supportive areas thereby reducing the need for the automobile. Reductions in the parking space standards also increases the financial feasibility of mid-rise building development, reducing space required for parking lots or reducing the requirement for structured parking located on site.

The rationale for reducing the residential parking space requirements is equally applicable to the intensification nodes and corridors, as well as the Urban Growth Centre. For existing properties located within the Urban Growth Centre, a reduction in the residential parking space requirements will encourage the potential for the redevelopment of commercial buildings to include residential uses. This reduction in the residential parking standards would reduce the number of spaces needed to be located on properties with existing buildings that may have difficulty locating additional parking spaces on site.

The recommended parking standard of 1 space per dwelling unit for the Intensification Areas represents a minimum requirement. This standard does not limit additional parking spaces from being constructed where necessary, allowing flexibility for land developers to determine the specific parking needs of their development project.

While the availability of additional parking continues to be demanded by residents for households with multiple cars or to accommodate visitors, developers will be able to match this demand with the appropriate number of spaces (i.e. 1.5 or 2 spaces per unit). As the Intensification Areas develop into mixed use areas complete with improved pedestrian infrastructure, frequent public transit, and the installation of bicycle lanes, it is expected that there will be a reduction in automobile reliance, and a reduction in the number of cars per family unit. At this point, developers will have the option of reducing their parking space ratio down to the minimum of 1 space per unit.

Staff note that a reduction in the minimum parking space requirements within the Urban Growth Centre may result in an increase in demand and usage of existing parking facilities, and may reduce opportunities for receiving cash-in-lieu of parking.

For all non-residential uses, the parking standards described in Table 4.6 of Zoning By-law 2009-141 will apply.

j) *Outdoor Amenity Area & Landscape Open Space*

An outdoor amenity area of 12m² per dwelling unit for the intensification nodes and corridors is recommended. Outdoor amenity area may be inclusive of landscape open

space, rooftop amenities (greenroofs, solariums, gardens, patios), private balconies, or other outdoor amenity feature.

Alternative front and rear yard amenities or landscaping, such as benches, art sculptures, or other creative streetscaping, will be strongly encouraged and should be incorporated into site design where feasible.

Density Targets for the Intensification Areas

46. The standards recommended by this Staff Report do not contain any requirements for minimum densities to be included within the City's Zoning By-law. Instead, the recommendations consist of a set of development standards such as minimum height requirements, setback set close to the property line, and specific built form types which result in development that facilitate medium and high density buildings.
47. The Official Plan contains target densities for the Intensification Areas under Section 4.2.2.6 (g). The policies explain that a target density of 50 to 120 units per hectare should be reached within the Intensification Nodes, and 50 units per hectare in the Intensification Corridors. Staff are of the opinion that the density targets found within the Official Plan provide a sufficient policy rationale for ensuring medium and high density development is attained within the Intensification Areas.
48. These target densities described within the Official Plan are long term goals that are not intended to be achieved on each individual property, but rather refer to the overall density planned for each of the Intensification Nodes and Corridors. The omission of a density target within the Zoning By-law allows the Intensification Nodes and Corridors to develop and intensify gradually over time. This flexibility is intended to facilitate greater variation and mix, ensuring that residential development in these areas is capable of fulfilling a wide range of housing and commercial needs.
49. Since 2013, Planning Services has been monitoring and reporting on the densities being attained throughout the City of Barrie, including the Intensification Areas. These densities will continue to be monitored over time to ensure that the targets, as set out in the Official Plan, are being sufficiently met.

Automobile Service Stations and Drive-Through Uses

50. With the exception of Yonge Street, each of the intensification nodes and corridors are primary arterial roads that connect to Highway 400, with many drivers passing through them on a daily basis. Because of this, the nodes and corridors may be convenient locations for the development of an automotive service station or a drive-through facility. Yonge Street, although not connecting to Highway 400, also turns into a provincial highway outside the city limits.
51. However, both of these uses are in sharp contrast to the type of uses and built form typically found in urban areas. Drive through facilities contribute to automobile dependency, are typically not a high density use, and utilize valuable lot area space for car stacking lanes. These attributes are contrary to the goals of intensification and the development of a pedestrian-oriented environment.
52. Currently, Section 4.12.1 of Zoning By-law 2009-141 prohibits the location of drive-through facilities within any Residential Zone, or within any Commercial or Industrial Zone abutting a Residential Zone except where a minimum distance of 15 metres separates the drive-through facility from any Residential Zone. The rationale behind this existing standard of the Zoning By-law is to keep residential areas free from the car emissions and noise associated with drive-through facilities. The zones being recommended by this Staff Report permit a mix of uses that include residential uses.

53. In light of this, Staff recommend that automotive service stations and drive-through uses not be permitted within the intensification nodes. However, Staff recommend that automotive service stations be considered in the intensification corridors and permitted only through a site specific rezoning. The rezoning process would allow Council to have greater control over the built form of the automotive service station, ensuring an appropriate fit with the urban environment intended for the corridors. Staff recommend that drive-through facilities continue not to be permitted within the intensification corridors.

Pre-zoning the Intensification Nodes and Corridors

54. If Council adopts the recommendation to create the new mixed use zoning categories, Staff recommend that Council direct Planning Services to investigate the appropriateness of rezoning land within the intensification nodes and corridors into the newly created zones. This practice is often referred to as 'pre-zoning', and refers to the City rezoning lands to permit the types of uses and built form intended for the area.
55. Staff expect that the pre-zoning process would occur on an area-by-area basis. The intention would not be to recommend a blanket rezoning across all of the nodes and corridors, but instead to focus on select areas identified as possessing the most immediate potential for redevelopment.
56. Staff recognise that each of the Intensification Nodes and Corridors are unique with their own set of neighbourhood features, challenges, and needs. The process of pre-zoning would allow staff to identify these neighbourhood distinctions and fine-tune the zoning standards to better respond to the characteristics of each area.
57. If the recommendation to pre-zone properties is approved by Council, a separate series of public meetings and landowner consultations would be required to consider the change of land uses throughout the Intensification Nodes and Corridors from their current land use zone to the new mixed-use zones.
58. The purpose of pre-zoning is to create an incentive for land owners and developers to implement the City's vision and to build in the designated intensification nodes and corridors, facilitating the development process. Pre-zoning will also create an incentive to construct the type of built form sought after for the intensification areas as site specific variations to these standards would require initiating an application under the Planning Act and potential appeals.
59. Under the current process, a developer would be required to undergo a rezoning process to achieve the type of built form desired for the nodes and corridors. In this situation, the City would be relying on the landowners to decide to implement the new zoning standards, who may instead prefer to continue taking advantage of existing zoning. The use of the existing zoning provisions would not result in the type of development intended for the intensification areas.
60. Pre-zoning would create an incentive to build according to the as-of-right built form, as developers could achieve a reasonable and profitable development without the need to undergo the time, expense, and uncertainty typically involved with the rezoning process.
61. If the Official Plan Amendment and Zoning By-law Amendment attached to this Staff Report are approved by Council, the recommended standards and provisions would still be available in advance of a decision to pre-zone any of the Intensification Nodes or Corridors. This would allow land developers to make use of the new zoning standards in order to attain the built form and mix of uses desired for the Intensification Areas.

Public Consultation Sessions

62. With respect to the comments and concerns expressed during the public meeting, Planning staff offer the following:

- a) *Concern about the ability to successfully fill commercial spaces with retail tenants and prevent vacancies. Desire for flexibility on the commercial space requirement*

Economics drives land development, including the market for both residential and commercial retail. The local and regional market will need to have a demand for these uses to ensure the success of a mixed use development. A lack of market demand for these uses may result in vacant commercial space in a mixed use building, which can impede the value of the local neighbourhood and jeopardize the ability to attract new residents and businesses into the community.

Partly due to the fact that land use planning has supported a separation of uses in the past, land developers tend to specialize in either residential or commercial forms of development, but often not in both. Mixed use buildings require development firms specializing in both residential and commercial space, as well as expertise on commercial tenant securement and management. Developers specializing in commercial development have the expertise to conduct a local market analysis and determine the feasibility of commercial uses in a mixed use building.

In response to concerns raised by the development community, the proposed zoning standards allow for flexibility with respect to the inclusion of commercial uses throughout the intensification corridors. Both mixed use and stand-alone residential uses are permitted within the intensification corridors. As an incentive to develop mixed use, Staff has recommended that additional height allowance be granted for developers who include ground floor commercial uses within their buildings. Staff recommend that the intensification nodes continue to require ground floor commercial, as these locations have been identified as capable of supporting high density mixed use development.

- b) *The neighbourhoods within the intensification nodes and corridors are different from each other and have unique needs. A blanket policy should not be applied across the City. Instead, neighbourhoods should be examined on a site-by-site basis.*

The Zoning By-law is a "blunt instrument" and is not intended to address unique or individual property requirements. The standards recommended in this Staff Report are designed to achieve the typical forms of development expected for the intensification nodes and corridors. However, individual property nuances, such as grading or topography challenges, cannot be addressed through city-wide zoning standards. Other planning tools, such as site plan control, are more appropriate for responding to these needs.

Staff have recommended that Council direct Planning Services to investigate the appropriateness for pre-zoning. If approved, the pre-zoning process will allow staff to consider the distinct characteristics of neighbourhoods and of individual sites in order to make zoning recommendations that respond to these.

- c) *Why do the proposed standards contradict other development proposals that are currently being considered? Developers do not adhere to the development standards of the Zoning By-law.*

The proposed standards and policies are currently still under consideration by Council, and cannot be considered in effect. If approved by Council, only applications received after the approval would be subject to the new development standards and policies.

All private land owners in Ontario possess the legal right to apply for a rezoning on their property to permit different uses and built forms (including taller and denser buildings), including those which may contradict the City of Barrie's land use plans.

It should also be noted that the Zoning By-law is not a dynamic tool that is capable of capturing frequent changes in the real estate market. Many properties have been zoned to permit the same uses for 50 years, and a rezoning may be necessary in order to update the zoning to reflect shifts in demand for certain uses and building types. A more accurate representation of future land uses can be obtained by consulting the City's Official Plan, which indicates uses planned for the next 20 years.

- d) *Concerns about high rise buildings being located adjacent to existing low density residential neighbourhoods, and the impacts of shadowing and loss of privacy.*

The proposed standards contain provisions designed to ensure a height transition between high rise and low rise buildings, which are intended to mitigate impacts of building height, shadow, and loss of privacy. This is achieved in part through a minimum 7.5 metre setback requirement between buildings in the intensification areas and adjacent low rise buildings. A height transition is also used, requiring buildings to step down with the use of a 45 degree angular plane down to a lower height of 7.5 metres (2.5 storeys). More information on this can be found in paragraph 48e of this Staff Report.

Part of the intention behind the creation of the proposed standards is to facilitate intensification in a mid-rise format, consisting of buildings that permit greater densities but without the need for very tall high-rises. The highest density uses within the Urban Growth Centre permit heights up to 45 metres, compared to the maximum of 25.5 metres recommended for the Intensification Nodes, and 16.5 metres for residential buildings within the Intensification Corridors.

Section 6.6 of the Official Plan contains policies regarding the design of tall buildings across the City of Barrie. The policies describe the need for shadow impact studies to be submitted where buildings taller than 3 storeys are proposed adjacent to existing low rise buildings.

- e) *There is currently no adequate pedestrian infrastructure to support walkability throughout the Intensification Nodes and Corridors.*

A central tenet of mixed use neighbourhoods is the ability for them to be walkable and pedestrian friendly. Adequate infrastructure is necessary to ensure a comfortable pedestrian experience, including sufficiently wide sidewalks, access to local public spaces, or frequent and reliable transit service. Staff acknowledges that pedestrian infrastructure throughout many parts of the intensification nodes and corridors is currently insufficient and require improvements.

This Staff Report recommends that the City of Barrie investigate the public realm improvements necessary to achieve complete streets that better support walkability. The Infrastructure & Growth Management Divisional Management Team (DMT) has had discussions on the creation of a cross-departmental committee intended to co-ordinate the necessary public realm improvements, and will continue to meet on this manner going forward.

- f) *What are the best means for "activating" the street?*

Research into successful active streets in other cities reveal a variety of means for "activating" the street, many of which are discussed in this Staff Report. To begin with,

the conditions for active streets need to be created. This includes the development of mixed use buildings that allow for a mix and variety of activities, high densities to create a sufficient local customer base, and improvements to the public realm to make the pedestrian experience more comfortable.

Second, there needs to be reasons for people to be attracted out onto the streets. This will primarily rely on the programming of tenants located in ground floor level spaces in mixed use buildings to bring people into the neighbourhood, such as retail, restaurants, or personal services. Equally important are attractive public spaces including parkettes, civic squares, public plazas, art installations, or community facilities such as libraries and recreation centres, which are all examples of uses that serve as places for people to gather in.

g) *Concerns about public notification of the proposed changes.*

A number of consultation sessions and public meetings were held over the course of February and March 2014. These meetings were advertised in the Barrie Examiner newspaper, on the City of Barrie's website, and through social media outlets including Facebook and Twitter. The statutory public meeting held at General Committee on March 31 was advertised in the local newspaper in compliance with the stipulations of the Planning Act.

The recommendations of this Staff Report are for general changes intended to create new zoning categories and provisions for mixed use development. The recommendations will not affect the existing zoning for any specific properties within the Intensification Nodes and Corridors. If the City decides to proceed with pre-zoning any of the Intensification Areas at a future date, further notices will be provided in the mail to all land owners within 120 metres of the affected sites in compliance with the requirements of the Planning Act.

ENVIRONMENTAL MATTERS

63. Intensification throughout the nodes and corridors may result in increased usage of transportation modes that are alternative to the automobile including transit, cycling, or walking, thereby reducing the production of greenhouse gases.

ALTERNATIVES

64. The following alternatives are available for consideration by General Committee:

Alternative #1

General Committee could decide not to support the adoption of the Official Plan and Zoning By-law Amendment.

This alternative is not recommended as it would not facilitate the creation of new zoning standards and Official Plan policies for the development of mixed-use buildings throughout the Intensification Nodes and Corridors.

Alternative #2

General Committee could decide not to direct staff to investigate the appropriateness of pre-zoning the Intensification Nodes and Corridors.

This alternative is not recommended, as the pre-zoning process allows Staff to consider the unique local characteristics of each of the neighbourhoods throughout the Intensification Nodes and Corridors. Pre-zoning also provides an incentive for land owners within the Nodes and

Corridors to redevelop their properties according to the type of uses and built form intended for the Intensification Areas.

FINANCIAL

65. Intensification offers the opportunity for the City to make better use of and increase its return on its investment of capital works, particularly existing municipal infrastructure. Intensification of jobs and people also has the benefit of potentially improving transit usage with associated revenue to the City's transit system.
66. The cost benefits for the recommendations of this Staff Report cannot fully be determined at this time, as this Staff Report only recommends high level general changes to the Official Plan and Zoning By-law which do not have immediate financial impacts. If the recommendations of this Staff Report are approved, the cost benefits determined during the implementation of the zoning standards at the site specific level will be reviewed at that time.

LINKAGE TO 2010-2014 COUNCIL STRATEGIC PLAN

67. The recommendation included in this Staff Report support the following goals identified in the 2010-2014 City Council Strategic Plan:
 - Manage Growth & Protect the Environment
68. The recommendations in this report are intended to speak to Council's strategic priorities as referenced above by amending the Zoning By-law to address urban design, height, and parking standards throughout the intensification areas. This will assist the City to grow in a more sustainable and efficient manner while providing opportunities for varied forms of housing and affordability to its citizens. The proposed zones will facilitate intensification, accommodating for projected population growth within the existing built-up boundary area.

Attachments – Appendix "A" –
Appendix "B" –
Appendix "C" - Map of the Urban Growth Centre, Intensification Nodes, and
Intensification Corridors

Appendix A: Official Plan Amendment

PART A - THE PREAMBLE

Purpose

The purpose of this amendment is to include policies in the City of Barrie's Official Plan that will provide a framework for the design and development of Mixed Use buildings throughout the Intensification Nodes and Corridors. The policies support the creation of a vibrant complete community featuring a mix of uses and activities, with pedestrian oriented development designed to frame abutting sidewalks with active commercial uses located at the street level of new buildings

Location

This is a text amendment for the creation of Section 4.9 in the City of Barrie Official Plan which relates to Mixed Use buildings located in the Intensification Nodes and Corridors, as identified on Schedule I of the Official Plan.

Basis

The basis for the creation of new Mixed Use policies stems from the recommendations of the Province's Growth Plan for the Greater Golden Horseshoe, and the City of Barrie's Intensification Study. The Growth Plan sets density targets to be achieved by municipalities across Ontario, including the City of Barrie which is expected to attain a residential population of 253,000 by 2041. The Growth Plan states that 40% of this residential population growth is to occur within the built up area of the City through intensification.

The Intensification Study, completed in 2009, recommends that growth be concentrated throughout a series of major arterial roads throughout the City of Barrie designated as the Intensification Areas, which were identified for their potential to support greater population growth through higher density development. The Intensification Study also makes recommendations for the creation of new policies and zoning standards intended to foster the mixed use, pedestrian oriented built form envisioned for the Intensification Areas.

The policies proposed by this amendment are intended to achieve the vision of the Growth Plan and Intensification Study by introducing new standards and provisions to facilitate Mixed Use development throughout the City of Barrie.

PART B - THE AMENDMENT

Details of the Amendment

That the Official Plan be amended by adding Section 4.9: Mixed Use, as follows:

4.9 MIXED USE

- (a) The Mixed Use policies will refer to lands located along the Intensification Nodes and Corridors, as identified on Schedule I – Intensification Areas.
- (b) For lands identified as Mixed Use, the policies of Section 4.9 will take precedence over other Land Use Policies contained in Section 4.2 Residential and 4.3 Commercial.

4.9.1 GOALS

- (a) To plan for new medium and high density development that supports an appropriate mix of residential, commercial, and institutional uses.
- (b) To create complete communities that support a mix of uses and activities, multiple modes of transportation, and a variety of housing forms to satisfy a range of incomes and tenures.
- (c) To foster a vibrant, compact, pedestrian-oriented environment that supports walkability, active transportation, and public transit.
- (d) To establish the Intensification Nodes and Corridors as the focal points of activity and a destination for surrounding neighbourhoods.

4.9.2 POLICIES

4.9.2.1 PERMITTED USES

- (a) Mixed Use areas will permit a variety of residential, commercial, and institutional uses. Multiple uses within the same building will be strongly encouraged, including the residential use of upper storeys with active uses located at the ground floor level. Active uses may include, but are not limited to, retail shops, business or personal services, and restaurants.
- (b) Private uses, including residential, amenity rooms, or automobile parking should not be located at the ground floor level adjacent to any principal streets within the Intensification Nodes.
- (c) The Zoning By-law will grant additional height permissions for Mixed Use buildings in the Intensification Corridors that incorporate active street level uses within the Intensification Corridors.
- (d) A variety of medium and high density residential uses in a range of types, sizes, affordability, and tenure, are encouraged throughout the Mixed Use areas to increase the resident population, accommodate for the City's population growth, and to create a local market for commercial uses.

- (e) Where residential uses are located at the street level in the Intensification Corridors, increased ground floor ceiling height will be provided to allow for the future conversion to commercial uses.
- (f) Mixed Use areas will be zoned to discourage uses that negatively affect their planned function. This includes automobile oriented uses such as automobile sales/leasing/repair establishment, car washes, and drive-through facilities. Automobile service stations will only be permitted within the Intensification Corridors through a site-specific Zoning By-law Amendment.

4.9.2.2 GENERAL POLICIES

- (a) Improvements to the public realm will contribute towards the creation of a pedestrian oriented environment. When possible, the City will make use of opportunities to redefine the street and boulevard within the existing right-of-way. Larger setbacks may be required in certain areas to facilitate the creation of larger boulevards, wider sidewalks, or landscaping features including trees and planters.
- (b) Transit supportive design will be promoted through public realm improvements and private land development that achieves higher densities and supports a variety of land uses to create local destinations throughout the Mixed Use areas.
- (c) Parks and civic open spaces are encouraged throughout the Intensification Areas to provide opportunities for recreation and social gathering. As these locations will experience the most optimal conditions for tree growth, larger tree species are encouraged to enhance the overall tree canopy.
- (d) The gradual evolution of the Intensification Nodes and Corridors into Mixed Use areas will be recognized through short-term design that supports long term development opportunities.
- (e) The City will generally not support rezoning applications that result in a decrease of density or a reduction in the variety of uses on a property within the Mixed Use areas.

4.9.2.3 DESIGN POLICIES

- (a) All lands located within the Intensification Nodes and Corridors will be subject to Site Plan Control, and will consider the recommendations of the Intensification Area Urban Design Guidelines.
- (b) The Mixed Use areas will achieve a pedestrian-oriented environment through a combination of appropriate development standards and design features in the Zoning By-law and Intensification Area Urban Design Guidelines.
- (c) Buildings will be sited to frame abutting streets and sidewalks in order to achieve a generally consistent setback and continuous built form. Façade step backs will reduce the visual and physical impacts of building height and will ensure human scaled development.

- (d) Larger setbacks may be granted for the purposes of creating outdoor patio space, publically accessible plazas, weather protection features such as canopies or building overhangs, for delineating entranceways, for the installation of public art, or other features which positively contribute towards the public realm.
- (e) Primary building entrances will be directly accessible from public sidewalks adjacent to any principal street located along the Intensification Nodes and Corridors. Non-residential ground floor units will be designed with transparent glass windows facing the street. Blank facades exposed to any principal streets will be avoided.
- (f) Intensification should be achieved with development that is compatible with the scale of adjacent properties, incorporating a built form transition from higher density to lower density areas. This can be accomplished through a combination of urban design features, including setbacks and stepping provisions.
- (g) Surface parking should be located at the rear of buildings. Where this is not feasible due to insufficient lot depth, surface parking should be located at the side of the building. No parking spaces will be located at the front of buildings in the Mixed Use areas.
- (h) Where underutilized blocks exceed 100 metres in depth and 250 metres in length, opportunities to subdivide these blocks into more manageable, walkable land parcels with walkways, drive-aisles, and where feasible, new roads should be considered.

Appendix B: Zoning By-law Amendment

Mixed Use

That the Zoning By-law be amended by adding Section 5.4 Mixed Use, as follows:

5.4 MIXED USE

5.4.1 MIXED USE GENERAL PROVISIONS

5.4.1.1 No person shall hereafter use any lands, nor erect, alter, enlarge or use any buildings or structures in any Mixed Use Zone except in accordance with the provisions of Section 5.4 and Section 4.0 of this By-law.

5.4.2 MIXED USE PERMITTED USES

5.4.2.1 The permitted uses in any Mixed Use Zone are listed in Table 5.4.1.

Table 5.4.1		
Uses	Zones	
	Mixed Use Node (MU1)	Mixed Use Corridor (MU2)
Residential Uses		
<i>Walk-up Apartment</i>	X	X
<i>Apartment Dwelling</i>	X	X
<i>Dwelling Unit(s) in conjunction with permitted commercial uses</i>	X	X
<i>Block/Cluster/Stacked Townhouse</i>	X	X
<i>Group Home</i>	X	X
Accessory Uses		
<i>Home Occupation ⁽¹⁾</i>	X	X
Commercial Uses		
<i>Bake Shop</i>	X	X
<i>Bank</i>	X	X
<i>Building Supply Centre</i>	X	X
<i>Bus Terminal</i>	X	X
<i>Bus Transfer Station</i>	X	X
<i>Conference Centre</i>	X	X
<i>Custom Workshop</i>	X	X
<i>Entertainment Establishment</i>	X	X
<i>Fitness or Health Club</i>	X	X
<i>Fitness or Health Club, Local</i>	X	X
<i>Florist</i>	X	X
<i>Funeral Establishment</i>	X	X
<i>Hotel, Motel</i>	X	X
<i>Laundry or Dry Cleaning Depot</i>	X	X
<i>Local Convenience Retail</i>	X	X
<i>Nursery or Garden Supply Centre</i>	X	X
<i>Office, Business or Professional</i>	X	X

Office, Medical	X	X
Outdoor Display and Sales Area	X	X
Parking Lot	X	X
Personal Service Store	X	X
Photography Studio	X	X
Private Club	X	X
Recreational Establishment	X	X
Rental Store	X	X
Restaurant	X	X
Retail Store	X	X
Service Store	X	X
Shopping Centre	X	X
Theatre	X	X
Trade Centre	X	X
Veterinary Clinic	X	X
Institutional		
Arena	X	X
Art Gallery	X	X
Assembly Hall	X	X
City Hall	X	X
Commercial School	X	X
Community Centre	X	X
Court House	X	X
Crisis Care Facility ⁽²⁾	X	X
Day Nursery	X	X
Library	X	X
Museum	X	X
Nursing Home	X	X
Place of Worship	X	X
Religious Institution	X	X
Rest Home	X	X
Retirement Home	X	X
Senior Citizens Home	X	X
Training and Rehabilitation Centre	X	X

(1) – See 5.4.2.5

(2) – See 5.4.2.7

5.4.2.3 Residential Uses

- a) The minimum dwelling unit floor area for any such dwelling unit shall comply with the standards set out in Section 5.3 of this By-law for the Apartment Dwelling Second Density (RA2) Zone.
- b) Where a lot contains more than 4 residential dwelling units, an outdoor amenity area based on a minimum of 12m² per unit shall be provided. Outdoor amenity area may be inclusive of landscape open space, rooftop amenities (greenroofs, solariums, gardens, and patios), private balconies, or other outdoor amenity feature. Outdoor amenity area shall or shall not be in a consolidated form.
- c) The parking spaces used for residential uses shall be designated for the exclusive use of the occupants of the residential dwelling units. Parking spaces designated for

residential uses shall be identified with a vertical sign indicating for residential use only.

5.4.2.4 Block/Cluster/Townhouses

No more than 8 block/cluster/townhouse units shall be constructed in a row.

5.4.2.5 Home Occupation

- a) *Home Occupations* shall be permitted in all residential uses located in a Mixed Use zone, in accordance with the provisions of Section 5.2.10 of this Zoning By-law.
- b) Notwithstanding the provisions of Section 5.2.10.1, the floor area devoted to a *Home Occupation* located within a *Block/Cluster/Stacked Townhouse* in a Mixed Use zone shall not exceed 50% of the total floor area of the dwelling.

5.4.2.6 Drive-Thru Facilities

Drive-Thru Facilities shall not be permitted in conjunction with any use within a Mixed Use zone.

5.4.2.7 Crisis Care Facility

Any crisis care facility shall be located a minimum distance of 300m from any other crisis care facility.

5.4.2.8 Highway 400 Commercial

Notwithstanding the Permitted Uses in Table 5.4.1, where a lot adjoins the right-of-way of Highway 400, the uses described in Section 6.2.5 of this Zoning By-law will apply.

5.4.3 MIXED USE STANDARDS

5.4.3.1 The uses permitted in the Mixed Use Zone are subject to the development standards referenced in Table 5.4.2.

Table 5.4.2			
Uses		Zones	
		Mixed Use Node (MU1)	Mixed Use Corridor (MU2)
Lot Area (min.)		-	-
Lot Frontage (min.)		-	-
Front Yard Setback (1)	Min.	1m for 75% of frontage	1m for 75% of frontage
	Max.	5m for 25% of frontage	5m for 25% of frontage
Side Yard Setback	Min.	-	-
	Min. Abutting Street or Laneway	-	3m
	Max.	-	3m
Rear Yard Setback (min)	Abutting Street or Laneway (2)	1.5m	1.5m
	Abutting Residential, OS, or EP Zone (3)	7m setback	7m setback
Front Façade Step-back (min.)		45 degree angular plane at height above 80% equivalent of right-of-way using 3m minimum step-backs	45 degree angular plane at height above 80% equivalent of right-of-way using 3m minimum step-backs
Side Façade Step-back (min.)		If adjacent to an OS zone, 5.5m at height above 80% equivalent of right-of-way	If adjacent to an OS zone, 5.5m at height above 80% equivalent of right-of-way

Rear Façade Step-back (min.)		45 degree angular plane above 7.5m using minimum 3m step-backs	45 degree angular plane above 7.5m using minimum 3m step-backs
Lot Coverage (max. % of lot area)		-	-
Gross Floor Area (max. % of lot area)		-	-
Street Level Floor Height (min.)		4.5m	4.5m
Building Height	Min.	10.5m	7.5m
	Max.	25.5m	16.5m ⁽⁴⁾
Minimum Coverage for Commercial uses (% of first storey GFA)		50%	- ⁽⁵⁾

(1) – See 5.4.3.2

(2) – See 5.4.3.3 (a)

(3) – See 5.4.3.3 (b)

(4) – See 5.4.3.4

(5) – See 5.4.3.5

5.4.3.2 Front Yard Setback

- a) Front yard setback areas shall be fully paved and seamlessly connected with abutting sidewalk.
- b) If ground floor usage abutting lot frontage is residential, a minimum 3m front yard setback will apply.

5.4.3.3 Rear Yard Setback

- a) Where a rear setback abuts a street or laneway, the setback may be used for soft or hard landscaping, or for a walkway.
- b) Where a rear yard setback abuts a Residential, Open Space, or Environmental Protection zone, the setback may be used for hard or soft landscaping, or for a two way laneway/driveway with sidewalks.

5.4.3.4 Building Height

If ground floor area use is a commercial or institutional use, the maximum building height permitted is 25.5m.

5.4.3.5 Street Level Commercial Uses

If street level use is a commercial or institutional use, the minimum coverage for the commercial or institutional use must be 50% of gross floor area for the street level floor area.

5.4.3.6 Yard Variations

Minimum front, side and rear yards shall be provided in accordance with the requirements of Table 5.4.3, subject to the provisions below.

Any part of any required yard, required by this By-law shall be open and unobstructed by any structure from grade level to the sky, with the following exceptions:

- a) accessory buildings subject to Section 5.4.3.7;
- b) sills, belt courses, cornices, eaves and gutters, chimney breasts or pilasters, which may project a distance of not more than 0.6m into a required yard;
- c) in the case of attached units, in which case no side yard shall be required on the interior side;
- d) fire escapes, which may project a distance of not more than 1.2m into a required side or rear yard, but in no case shall the side or rear yard, except where none is required, be reduced to less than 0.6m;
- e) balconies on apartment dwellings, where located at a greater height than the bottom of the first floor ceiling joists, may project a distance of not more than 1.5m into a required yard, but in no case shall the side yard, except where none is required, be reduced to less than 1.8m to any side lot line.

5.4.3.7 Accessory Buildings and Structures

Accessory Buildings and Structures shall only be permitted in conjunction with *Residential Uses* identified in Table 5.4.1. No other *building or structure*, except a *parking structure underground* which is accessory to any residential use in any zone shall:

- a) exceed a height of 4m;
- b) occupy any part of a *front yard* or *side yard*;
- c) be *erected* closer than 0.6m from the *rear lot line*;
- d) be *erected* closer than 0.6m from the *side lot line*, except in the case of attached units, in which case no *side yard* shall be required on the interior side where the *accessory building or structure* is attached to the *main building*;
- e) the width of a *boat house* and *boat port* shall not exceed 30% of the width of the lot measured at the shoreline;
- f) collectively exceed 10% lot coverage for detached accessory structures or a maximum of 50m² whichever is lesser.

5.4.3.8 Additional Standards for Lands Abutting Highway 400

Notwithstanding the standards of Table 5.4.2, where a lot adjoins the right-of-way of Highway 400, the standards of Section 6.3.3 will apply.

5.4.3.9 Rooftop Mechanical/Electrical Structures

Maximum building height standards are not inclusive of rooftop mechanical/electrical structures, but will be subject to any 45 degree angular plane requirement. Mechanical/electrical structures will be screened within rooftop penthouses or through the use of parapets.

5.4.4.0 Landscape Buffer Areas

Notwithstanding the provisions of Section 4.8.2.1, where any *lot* in a Mixed Use zone abuts a *lot* in a Residential Zone, with the exception of the RA1 and RA2 Apartment Dwelling zones, a continuous *landscaped buffer area* of a minimum width of 3m shall be provided along the abutting *lot* line of the *lot*, and a continuous tight board fence with a minimum height of 2m is to be constructed along the *lot line*.

5.4.4.1 Parking for Apartment Dwellings

Parking spaces including aisles required for an *apartment dwelling unit* in the Mixed Use zone shall have a maximum *lot coverage* of 35%.

General Provisions and General Standards

That the Zoning By-law be amended within Section 4.6 Parking Standards to add the following to Table 4.6:

Table 4.6	
Uses	Parking Standards
<i>Residential uses located within a Mixed Use zone</i>	1 space per dwelling unit

That Section 4.8.2.2 Landscape Buffer Areas: Industrial Zones Adjacent to Commercial, Institutional, Open Space and Environmental Protection Zones of the Zoning By-law be amended as follows:

4.8.2.2 Industrial Zones Adjacent to Commercial, Institutional, Open Space and Environmental Protection Zones

Where any *lot* in an Industrial Zone abuts a *lot* in a Commercial, Institutional, Mixed Use, Open Space or Environmental Protection Zone, a continuous landscaped buffer area of a minimum width of 3m shall be provided along the abutting *lot line* of the *lot*.

Residential Zone

That Section 5.3.5 Accessory Buildings and Structures of the Zoning By-law be amended as follows:

5.3.5 Accessory Buildings and Structures

No other *building or structure*, except a *parking structure underground* which is accessory to any residential use in any *zone*, with the exception of the Mixed Use zones, shall:

- a) exceed a height of 4m; (By-law 2010-195)
- b) occupy any part of a *front yard*, except for an in-ground swimming pool, a *carport*, a *deck* or a *porch*;
- c) be *erected* closer than the 3m from the exterior *side lot line* in the case of a *corner lot*, except for the *rear yard* in which case the minimum setbacks shall be 1m;
- d) be *erected* closer than 7m from the *front lot line*;
- e) be *erected* closer than 0.6m from the *rear lot line*;
- f) be *erected* closer than 0.6m from the *side lot line*, except in the case of attached units, in which case no *side yard* shall be required on the interior side where the *accessory building or structure* is attached to the *main building*;
- g) the width of a *boat house* and *boat port* shall not exceed 30% of the width of the lot measured at the shoreline;
- h) collectively exceed 10% lot coverage for detached accessory structures or a maximum of 50m² whichever is lesser. The 10% lot coverage permitted for accessory buildings and structures is in addition to the lot coverage as set out in Table 5.3. (By-law 2010-195)

That Section 5.3.6.1 a) Parking Standards: Parking in Front Yards of the Zoning By-law be amended as follows:

5.3.6.1 Parking in Front Yards

- a) That the *driveway* and/or *parking space* that is located in the front yard of a property accessed by a public street cannot exceed the maximum percentage of the front yard as follows:

Zone	Front Yard Parking Coverage
R1, R2, R3	50%
R4	60%
RM1, RM1-SS	60%
RM2, RM2-TH ⁽¹⁾	60%
MU1, MU2	0%

That Section 5.3.6.2 a) Parking Standards: Parking for Apartment Dwellings of the Zoning By-law be amended as follows:

5.3.6.2 Parking for Apartment Dwellings

- a) *Parking spaces* including aisles required for an *apartment dwelling unit* in any zone, with the exception of the Mixed Use zones, shall have a maximum *lot coverage* of 35%.

That Section 5.3.7.2 Landscape Buffer Areas: Apartment Dwellings of the Zoning By-law be amended as follows:

5.3.7.2 Apartment Dwellings

A continuous *landscaped buffer area* shall be provided along the side and *rear lot lines* of any *lot* which is occupied by an *Apartment Dwelling*, with the exception of the Mixed Use zones. The *landscaped buffer area* shall be 3m in width along the side and *rear lot lines*.

Appendix C: Map of the Urban Growth Centre, Intensification Nodes, and Intensification Corridors

